

PRZEKRÓJ H-H
SKALA 1 : 9

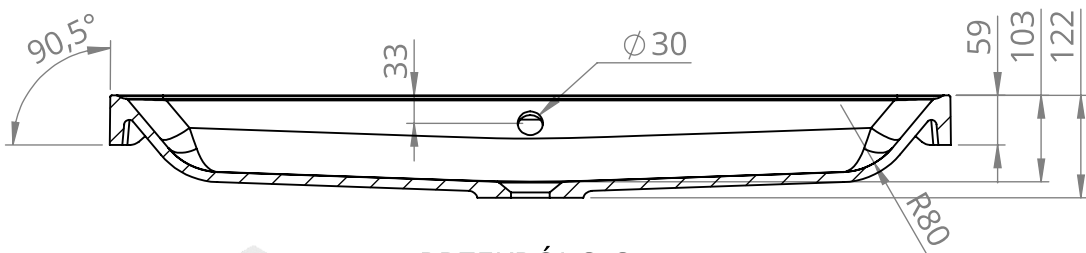

PRZEKRÓJ G-G
SKALA 1 : 9

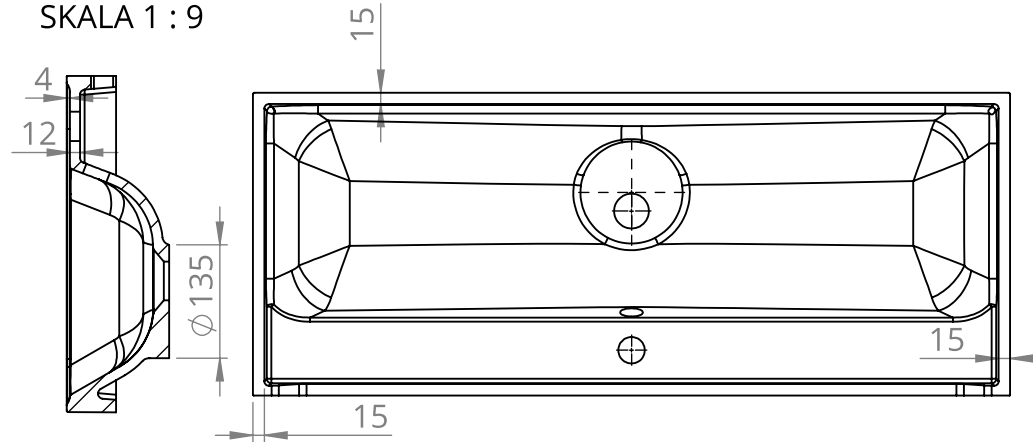